

Subminiature Relay that Switches up to 5 A

- Subminiature: 20 × 10 × 10 mm (L × W × H).
- Low power consumption: 200 mW.
- Unique moving loop armature reduces relay size, magnetic interference, and contact bounce time.
- Single- and double-winding latching types also available.

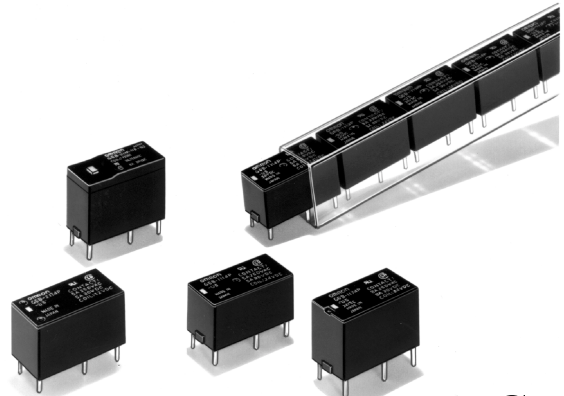

RC+

Ordering Information

| Classification | Contact form | Straight PCB | Self-clinching PCB |
|----------------------------------|-----------------|---------------|--------------------|
| Single-side stable | SPST-NO | G6B-1114P-US | G6B-1114C-US |
| | SPST-NO+SPST-NC | G6B-2114P-US | G6B-2114C-US |
| | DPST-NO | G6B-2214P-US | G6B-2214C-US |
| | DPST-NC | G6B-2014P-US | G6B-2014C-US |
| Single-winding latching | SPST-NO | G6BU-1114P-US | G6BU-1114C-US |
| Double-winding latching | SPST-NO | G6BK-1114P-US | G6BK-1114C-US |
| High-capacity single-side stable | SPST-NO | G6B-1174P-US | G6B-1174C-US |

Note: When ordering, add the rated coil voltage to the model number.

Example: G6B-1114P-US 12 VDC

Rated coil voltage

Model Number Legend

G6B - - VDC

1 2 3 4 5 6 7

1. Relay Function

- None: Single-side stable
- U: Single-winding latching
- K: Double-winding latching

2. Contact Form

- 21: SPST-NO + SPST-NC
- 22: DPST-NO
- 20: DPST-NC
- 11: SPST-NO

3. Contact Type

- 1: Standard
- 7: High-capacity

4. Enclosure Ratings

- 4: Fully sealed

5. Terminals

- P: Straight PCB
- C: Self-clinching PCB

6. Approved Standards

- US: UL/CSA certified

7. Rated Coil Voltage

- 5, 6, 12, 24 VDC

■ Accessories (Order Separately)

Back Connecting Sockets

| Applicable relay | Back connecting socket* |
|--------------------|-------------------------|
| G6B(U)-1114P-US | P6B-04P |
| G6BK-1114P-US | P6B-06P |
| G6B-2j j 4P-US-P6B | P6B-26P |
| G6B-1174P-US | P6B-04P |

*Not applicable to the self-clinching type.

| | |
|-----------------|--------|
| Removal Tool | P6B-Y1 |
| Hold-down Clips | P6B-C2 |

Specifications

■ Coil Ratings

Single-side Stable Type

| Item | SPST-NO | | | | | SPST-NO + SPST-NC, DPST-NO, DPST-NC | | | | |
|-------------------------------------|---------------------------|------|------|------|-------|-------------------------------------|------|-----|-----|-------|
| | 3 | 5 | 6 | 12 | 24 | 3 | 5 | 6 | 12 | 24 |
| Rated voltage (VDC) | 3 | 5 | 6 | 12 | 24 | 3 | 5 | 6 | 12 | 24 |
| Rated current (mA) | 67 | 40 | 33.3 | 16.7 | 8.3 | 100 | 60 | 50 | 25 | 12.5 |
| Coil resistance (Ω) | 45 | 125 | 180 | 720 | 2,880 | 30 | 83.3 | 120 | 480 | 1,920 |
| Coil inductance (H) (ref. value) | Armature OFF | 0.20 | 0.28 | 0.31 | 1.2 | 4.9 | --- | --- | --- | --- |
| | Armature ON | 0.18 | 0.26 | 0.28 | 1.1 | 4.1 | --- | --- | --- | --- |
| Must operate voltage | 70% max. of rated voltage | | | | | 80% max. of rated voltage | | | | |
| Must release voltage | 10% min. of rated voltage | | | | | | | | | |
| Max. voltage | 130% of rated voltage | | | | | 110% of rated voltage | | | | |
| Power consumption | Approx. 200 mW | | | | | Approx. 300 mW | | | | |

Single-winding Latching Type

| | | | | | |
|-------------------------------------|---------------------------|--------------|--------------|--------------|----------------|
| Rated voltage | 3 VDC | 5 VDC | 6 VDC | 12 VDC | 24 VDC |
| Rated current | 67 mA | 40 mA | 33.3 mA | 16.7 mA | 8.3 mA |
| Coil resistance | 45 Ω | 125 Ω | 180 Ω | 720 Ω | 2,880 Ω |
| Coil inductance (H) (ref. value) | Armature OFF | 0.20 | 0.28 | 0.31 | 1.2 |
| | Armature ON | 0.18 | 0.26 | 0.28 | 1.1 |
| Must operate voltage | 70% max. of rated voltage | | | | |
| Must release voltage | 70% min. of rated voltage | | | | |
| Max. voltage | 130% of rated voltage | | | | |
| Power consumption | Approx. 200 mW | | | | |

Double-winding Latching Type

| | | | | | | |
|--------------------|--|---------------|---------------|----------------|--------------|------|
| Rated voltage | 3 VDC | 5 VDC | 6 VDC | 12 VDC | 24 VDC | |
| Set coil | Rated current | 93.2 mA | 56 mA | 46.8 mA | 23.3 mA | |
| | Coil resistance | 32.2 Ω | 89.2 Ω | 128.5 Ω | 515 Ω | |
| | Coil inductance (H) (ref. value) | Armature OFF | 0.11 | 0.15 | 0.18 | 0.52 |
| | | Armature ON | 0.11 | 0.15 | 0.18 | 0.52 |
| Reset coil | Rated current | 93.2 mA | 56 mA | 46.8 mA | 23.3 mA | |
| | Coil resistance | 32.2 Ω | 89.2 Ω | 128.5 Ω | 515 Ω | |
| | Coil inductance (H) (ref. value) | Armature OFF | 0.11 | 0.15 | 0.18 | 0.52 |
| | | Armature ON | 0.11 | 0.15 | 0.18 | 0.52 |
| Must set voltage | 70% max. of rated voltage | | | | | |
| Must reset voltage | 70% min. of rated voltage | | | | | |
| Max. voltage | 130% of rated voltage | | | | | |
| Power consumption | Set coil: Approx. 280 mW Reset coil: Approx. 280 mW | | | | | |

Note: 1. The rated current and coil resistance are measured at a coil temperature of 23°C with a tolerance of $\pm 10\%$.
2. Operating characteristics are measured at a coil temperature of 23°C.

■ Contact Ratings

| Item | SPST-NO | | SPST-NO + SPST-NC, DPST-NO, DPST-NC | |
|------------------------|--------------------------------------|--|--------------------------------------|--|
| | Resistive load ($\cos\phi = 1$) | Inductive load ($\cos\phi = 0.4$; L/R = 7 ms) | Resistive load ($\cos\phi = 1$) | Inductive load ($\cos\phi = 0.4$; L/R = 7 ms) |
| Rated load | 5 A at 250 VAC; 5A at 30 VDC | 2 A at 250 VAC; 2 A at 30 VDC | 5 A at 250 VAC; 5A at 30 VDC | 1.5 A at 250 VAC; 1.5 A at 30 VDC |
| Contact material | AgCdO | | | |
| Rated carry current | 5 A | | | |
| Max. switching voltage | 380 VAC, 125 VDC | | | |
| Max. switching current | 5 A | | | |
| Max. switching power | 1,250 VA, 150 W | 500 VA, 60 W | 1,250 VA, 150 W | 375 VA, 80 W |
| Min. permissible load | 10 mA at 5 VDC | | | |

| Item | SPST-NO (High-capacity) | |
|------------------------|-----------------------------------|---|
| | Resistive load ($\cos\phi = 1$) | Inductive load ($\cos\phi = 0.4$; L/R = 7 ms) |
| Rated load | 8 A at 250 VAC; 5A at 30 VDC | 2 A at 250 VAC; 2 A at 30 VDC |
| Contact material | AgCdO | |
| Rated carry current | 8 A | |
| Max. switching voltage | 380 VAC, 125 VDC | |
| Max. switching current | 8 A | |
| Max. switching power | 2,000 VA, 150 W | |
| Min. permissible load | 10 mA at 5 VDC | |

Note: P level: $\lambda_{60} = 0.1 \times 10^{-6}$ /operation

■ Characteristics

| | |
|-----------------------------|---|
| Contact resistance | 30 m Ω max. |
| Operate (set) time | 10 ms max. (mean value: 1-pole approx. 3 ms, 2-pole approx. 4 ms) |
| Release (reset) time | Single-side stable types: 10 ms max. (mean value: 1-pole approx. 1 ms, 2-pole approx. 2 ms) Latching types: 10 ms max. (mean value: approx. 3 ms) |
| Min. set/reset signal width | Latching type: 15 ms min. (at 23°C) |
| Max. operating frequency | Mechanical: 18,000 operations/hr Electrical: 1,800 operations/hr (under rated load) |
| Insulation resistance | 1,000 M Ω min. (at 500 VDC, at 250 VDC between set coil and reset coil) |
| Dielectric strength | 3,000 VAC (Latching types: 2,000 VAC), 50/60 Hz for 1 min between coil and contacts 1,000 VAC, 50/60 Hz for 1 min between contacts of same polarity 250 VAC, 50/60 Hz for 1 min between set and reset coils 2,000 VAC, 50/60 Hz for 1 min between contacts of different polarity |
| Vibration resistance | Destruction: 10 to 55 Hz, 1.5-mm double amplitude Malfunction: 10 to 55 Hz, 1.5-mm double amplitude |
| Shock resistance | Destruction: 1,000 m/s ² Malfunction: Single-side stable: 100 m/s ² ; Latching: 300 m/s ² |
| Life expectancy | Mechanical: 50,000,000 operations min. (at 18,000 operations/hr) Electrical: 100,000 operation min. (at 1,800 operations/hr) |
| Ambient temperature | Operating: -25°C to 70°C (with no icing) Storage: -25°C to 70°C (with no icing) |
| Ambient humidity | Operating: 45% to 85% Storage: 45% to 85% |
| Weight | Double-winding latching: Approx. 3.7 g High-capacity: Approx. 4.6 g Double pole: Approx. 4.5 g Other: Approx. 3.5 g |

Note: The data shown above are initial values.

■ Approved Standards

UL508 (File No. E41643)/CSA C22.2 No.14 (File No. LR31928)

| Model | Contact form | Coil rating | Contact rating |
|--|---|-------------|--|
| G6B-1114P-US G6B-1114C-US G6BU-1114P-US G6BU-1114C-US G6BK-1114P-US G6BK-1114C-US | SPST-NO | 3 to 24 VDC | 5 A, 250 VAC (general use) 5 A, 30 VDC (resistive load) |
| G6B-1174P-US G6B-1174C-US | | | 8 A, 250 VAC (general use) 8 A, 30 VDC (resistive load) |
| G6B-2114P-US G6B-2114C-US G6B-2214P-US G6B-2214C-US G6B-2014P-US G6B-2014C-US | SPST-NO + SPST-NC DPST-NO DPST-NC | | 5 A, 250 VAC (general use) 5 A, 30 VDC (resistive load) |

Engineering Data

G6B-1114P-US

Maximum Switching Power

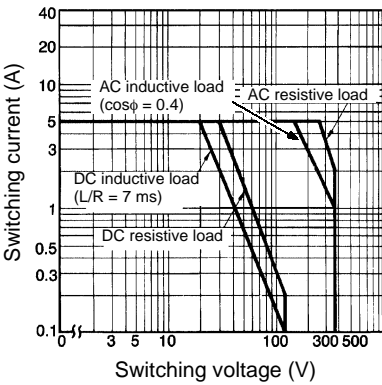

Life Expectancy

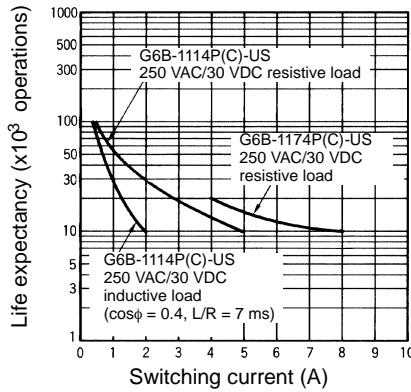

Ambient Temperature vs. Maximum Coil Voltage

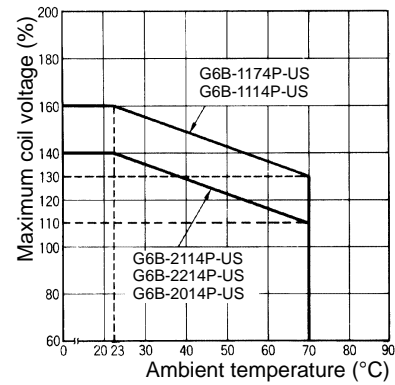

Note: The maximum coil voltage refers to the maximum value in a varying range of operating power voltage, not a continuous voltage.

G6B-2114P-US, G6B-2214P-US
G6B-2014P-US

Maximum Switching Power

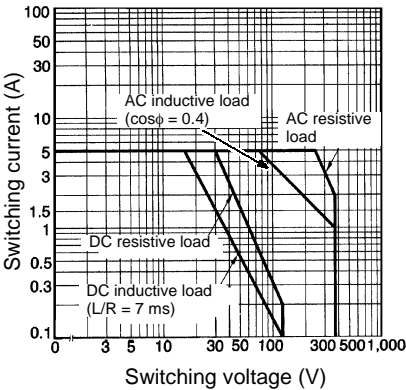

Life Expectancy

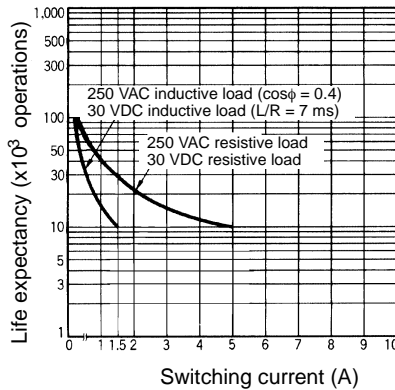

Dimensions

Note: 1. All units are in millimeters unless otherwise indicated.

2. Orientation marks are indicated as follows:  

G6B-1114P-US G6BU-1114P-US

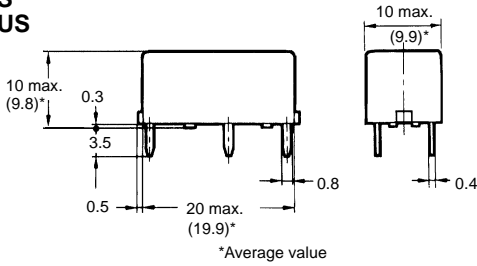
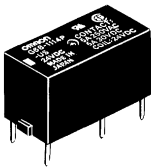

Terminal Arrangement/Internal Connections (Bottom View)
G6B-1114P, -1114C

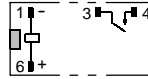

Mounting Holes (Bottom View)
G6B-1114P, -1114C
G6BU-1114P, -1114C

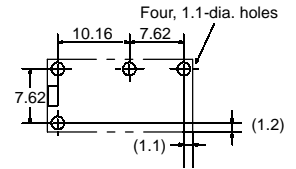

G6B-1114C-US G6BU-1114C-US

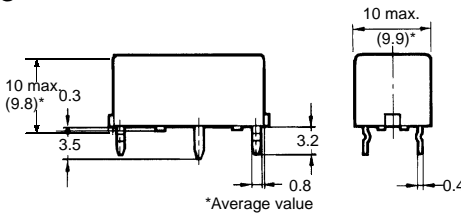
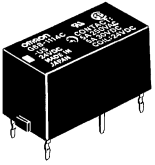

G6BU-1114P, -1114C

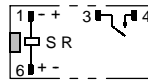

G6BK-1114P-US

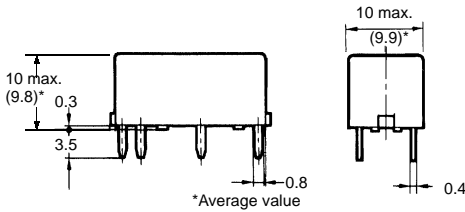
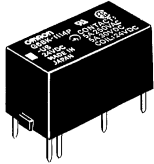

Terminal Arrangement/Internal Connections (Bottom View)
G6BK-1114P, -1114C

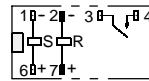

Mounting Holes (Bottom View)
G6BK-1114P, -1114C

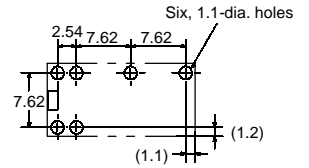

G6BK-1114C-US

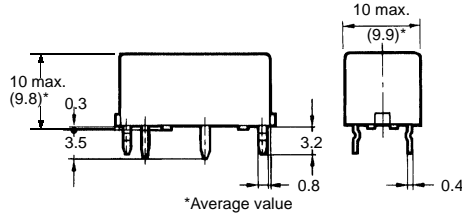
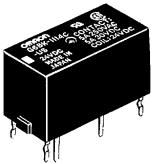

G6B-1174P-US

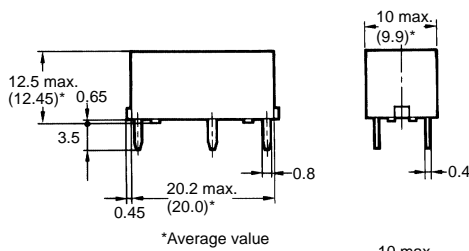
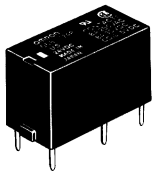

Terminal Arrangement/Internal Connections (Bottom View)
G6B-1174P, -1174C

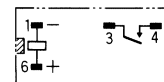

Mounting Holes (Bottom View)

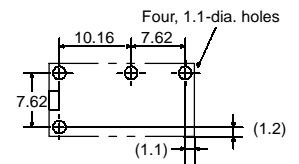

G6B-1174C-US

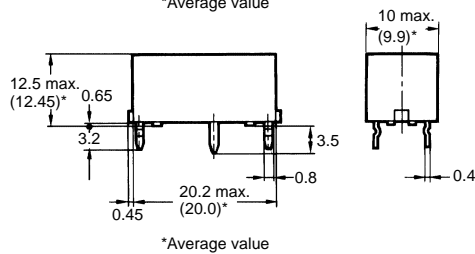
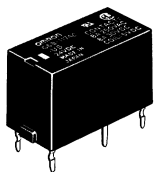

**G6B-2114P-US
G6B-2214P-US
G6B-2014P-US**

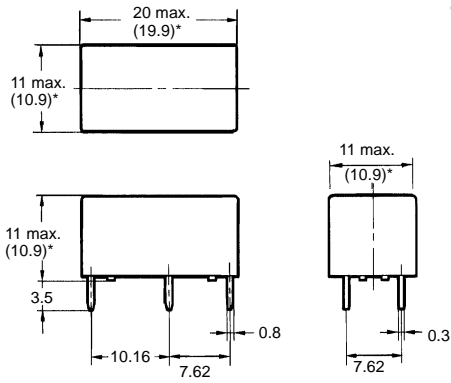
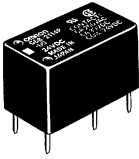

*Average value

Terminal Arrangement/Internal Connections (Bottom View)

G6B-2114P-US

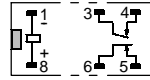

G6B-2214P-US

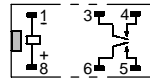

G6B-2014P-US

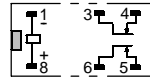

Mounting Holes (Bottom View)

Tolerance: ± 0.1

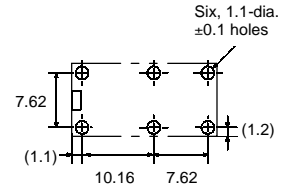

**G6B-2114C-US
G6B-2214C-US
G6B-2014C-US**

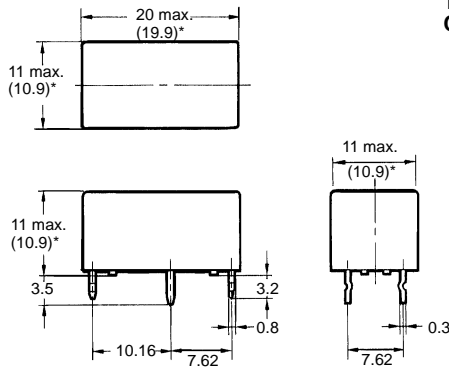
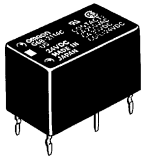

*Average value

Terminal Arrangement/Internal Connections (Bottom View)

G6B-2114C-US

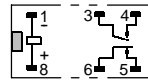

G6B-2214C-US

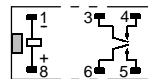

G6B-2014C-US



Mounting Holes (Bottom View)

Tolerance: ± 0.1

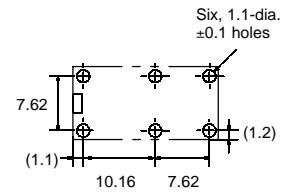

**Back Connecting Socket
P6B-04P**

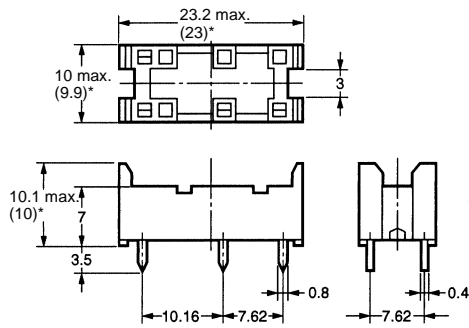
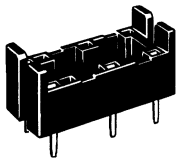

*Average value

Mounting Holes (Bottom View)

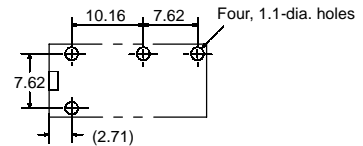

P6B-06P

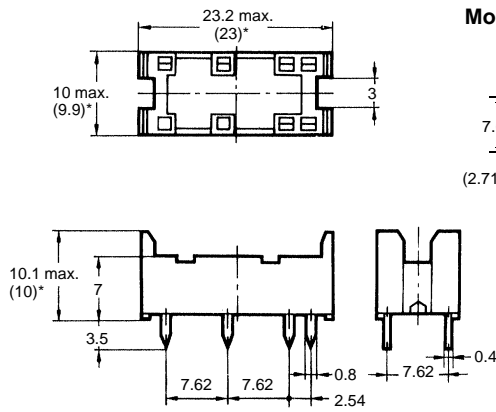
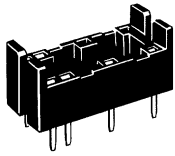

*Average value

Mounting Holes (Bottom View)

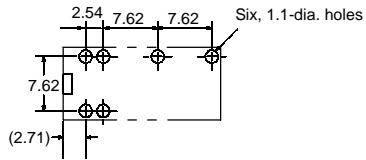

P6B-26P

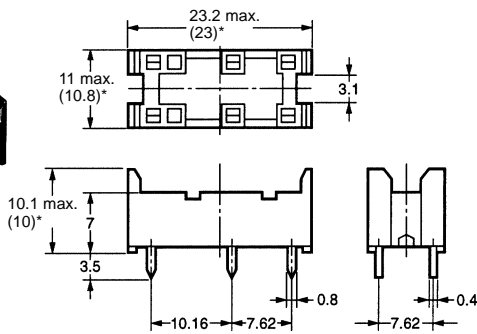
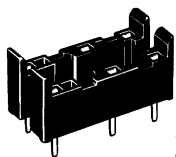

*Average value

Mounting Holes (Bottom View)

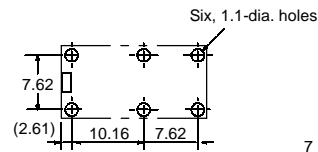

Note: Rated current of socket is 5 A max.

Mounting Height of Relay with Connecting Socket

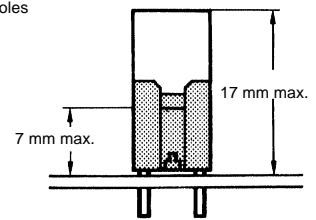

Note: Height of G6B-1174P-US is 19.5 mm max.

**Removal Tool
P6B-Y1**

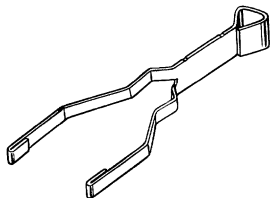

**Hold-down Clips
P6B-C2**

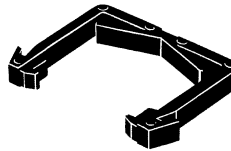

Note: P6B-C2 Hold-down Clips cannot be used for G6B-1174P-US.

ALL DIMENSIONS SHOWN ARE IN MILLIMETERS.

To convert millimeters into inches, multiply by 0.03937. To convert grams into ounces, multiply by 0.03527.