

Solid-state Relay

G3MB

Low-cost, Subminiature PCB-mounting SSR Switching 2 A

- Bottom is approximately three times as small as that of the G3M and ideal for high-density PCB applications.
- DC input-AC output for 2-A load at 25°C.
- Mono-block lead frame incorporating terminals, heat sink, and a PCB directly mounted with bare chips made it possible to miniaturize the relay.
- Standard models approved by UL, CSA and -UTU models by VDE (TUV).

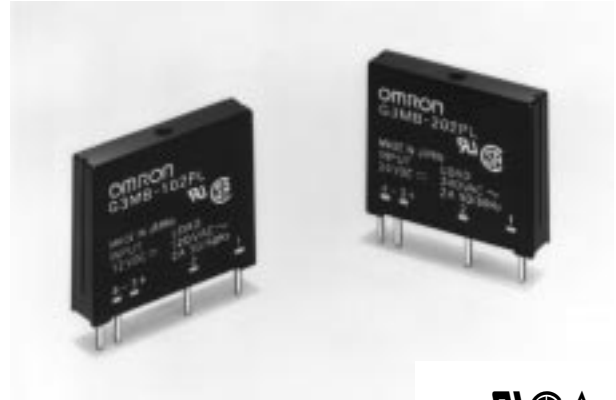

Ordering Information

Isolation	Zero cross function	Indicator	Input resistor	Snubber circuit	Applicable output load	Rated input voltage	Model
Phototriac	No	No	Yes	Yes	2 A at 100 to 120 VAC (rated load voltage)	5 VDC	G3MB-102PL (-UTU)
						12 VDC	
						24 VDC	
	Yes				2 A at 100 to 240 VAC (rated load voltage)	5 VDC	G3MB-202P (-UTU) G3MB-202P-4 (-UTU)
						12 VDC	
						24 VDC	
	No	5 VDC	G3MB-202PL (-UTU) G3MB-202PL-4 (-UTU)				
				12 VDC			
	Yes	No	No	No	*1	G3MB-202PEG-4 (-UTU) G3MB-202PLEG-4 (-UTU)	
							No

Note: When ordering models conforming to VDE (TÜV), add “-UTU” to the model number.

* Recommended Operating Conditions

Item	Min.	Standard	Max.
Forward current	5 mA	10 mA	20 mA
Must release voltage	0	---	1 V

Specifications

■ Ratings

Input Resistor Contact

Rated voltage	Operating voltage	Impedance	Voltage levels	
			Must operate voltage	Must release voltage
5 VDC	4 to 6 VDC	440 Ω ±20%	4 VDC max.	1 VDC min.
12 VDC	9.6 to 14.4 VDC	1 kΩ ±20%	9.6 VDC max.	
24 VDC	19.2 to 28.8 VDC	2.2 kΩ ±20%	19.2 VDC max.	

Note: Each model has 5-VDC, 12-VDC, and 24-VDC input versions.

No Input Resistor

Item	Max.
LED forward current	50 mA
Repetitive peak LED forward current	1 A
LED reverse voltage	5 V

Output

Model	Applicable load			
	Rated load voltage	Load voltage range	Load current	Inrush current
G3MB-102PL	100 to 120 VAC, 50/60 Hz	75 to 132 VAC, 50/60 Hz	0.1 to 2 A	30 A (60 Hz, 1 cycle)
G3MB-202P G3MB-202PL	100 to 240 VAC, 50/60 Hz	75 to 264 VAC, 50/60 Hz		
G3MB-202PEG-4 G3MB-202PLEG-4				

■ Characteristics

Item	G3MB-102PL	G3MB-202P, -202P-4, -202PEG-4	G3MB-202PL, -202PL-4, -202PLEG-4
Operate time	1 ms max.	1/2 of load power source cycle + 1 ms max.	1 ms max.
Release time	1/2 of load power source cycle + 1 ms max.		
Output ON voltage drop	1.6 V (RMS) max.		
Leakage current	1 mA max. (at 100 VAC)	1.5 mA max. (at 200 VAC)	
Insulation resistance	1,000 M Ω min. (at 500 VDC)		
Dielectric strength	2,500 VAC, 50/60 Hz for 1 min		
Vibration resistance	Malfunction: 10 to 55 Hz, 0.75-mm double amplitude		
Shock resistance	Malfunction: 1,000 m/s ²		
Ambient temperature	Operating: -30°C to 80°C (with no icing or condensation) Storage: -30°C to 100°C (with no icing or condensation)		
Ambient humidity	Operating: 45% to 85%		
Approved standards	UL508 File No. E64562 CSA C22.2 (No.14) File No. LR35535 TÜV R9351062 (EN60950) ("-UTU" type)		
Weight	Approx. 5 g		

Engineering Data

Load Current vs. Ambient Temperature Characteristics

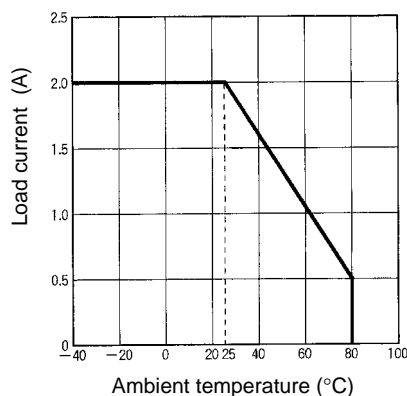

Inrush Current Resistivity

Non-repetitive (Keep the inrush current to half the rated value if it occurs repetitively.)

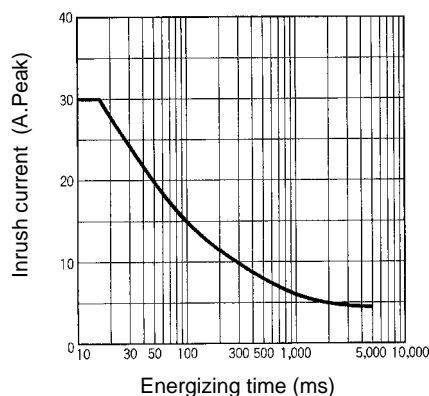

Dimensions

Note: All units are in millimeters unless otherwise indicated.



G3MB-□02P□

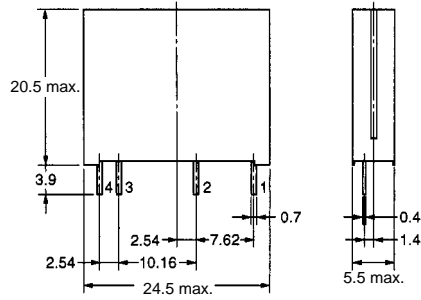

**PCB Dimensions
(Bottom View)**

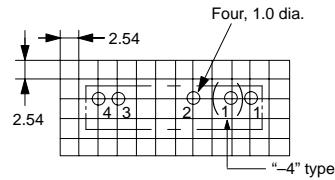

**Terminal Arrangement/
Internal Connections
(Bottom View)**

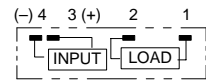

G3MB-202P□□□-4

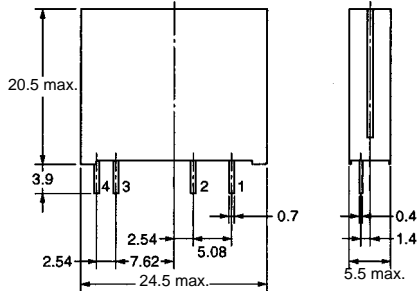

Precautions

Soldering must be completed within 10 seconds at 260°C or less.

Make sure that the space between the bottom of the relay and the PCB is 0.1 mm or less. When making holes on the PCB for the relay's edge terminals, the hole diameters should be slightly smaller than the actual diameters of the edge terminals. This will reduce unnecessary space between the bottom of the relay and the PCB.

To use the SSR output for phase control, select a model that does not incorporate a zero-cross function.

The SSR case serves to dissipate heat. When mounting more than three SSRs as a group, pay attention to the ambient temperature rise and install the Relays so that they are adequately ventilated. If poor ventilation is unavoidable, reduce the load current by half.

Protective Component

The input circuitry does not incorporate a circuit protecting the SSR from being damaged due to a reversed connection. Make sure that the polarity is correct when connecting the input lines.

ALL DIMENSIONS SHOWN ARE IN MILLIMETERS.

To convert millimeters into inches, multiply by 0.03937. To convert grams into ounces, multiply by 0.03527.