

Surface-mountable 2.5 GHz Band Miniature SPDT High-frequency Relay

- Superior high-frequency characteristics, such as an isolation of 60 dB min., insertion loss of 0.2 dB max., and V.S.W.R. of 1.2 max. at 2.5 GHz (50 Ω).
- Surface-mounting terminals and superior high-frequency characteristics combined through adoption of tri-plate micro strip type transmission lines.
- Ultra-miniature at 20 × 9.4 × 8.9 mm (L × W × H).
- Serialized relay lineup consisting of single-winding latching type (200 mW), double-winding latching type (360 mW), and reverse-arrangement contact type.
- Y-shape terminal arrangement that simplifies wiring to PCBs.

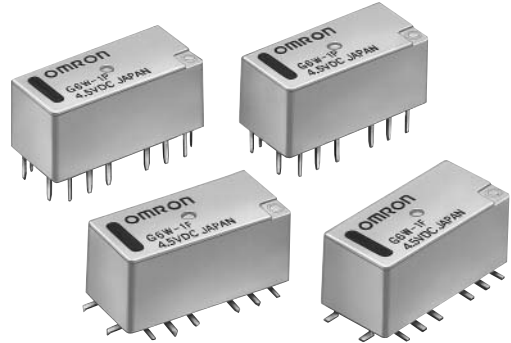

Ordering Information

Classification				Single-side stable	Single-winding latching	Double-winding latching
SPDT	Fully sealed	Through-hole terminal	Y-shape terminal	G6W-1P	G6WU-1P	G6WK-1P
		Surface-mounting terminal	Y-shape terminal	G6W-1F	G6WU-1F	G6WK-1F

Note: When ordering, add the rated coil voltage to the model number.

Example: G6W-1P 12 VDC

└── Rated coil voltage

Model Number Legend:

G6W □ - □□□ - □

1 2 3 4 5

1. Relay function

- None: Single-side stable
- U: Single-winding latching
- K: Double-winding latching

2. Contact form

- 1: SPDT

3. Terminal shape

- F: Surface-mounting terminals
- P: PCB terminals

4. Terminal Arrangement

- None: Y-shape terminal arrangement (standard)

5. Classification

- None: Standard contact arrangement
- R: Reverse contact arrangement

Application Examples

Mobile phone base station (W-Cdma, UMTS, Cdma-2000, PCS), wireless LAN, and measurement devices.

Specifications

■ Contact Ratings

Item	Load	Resistive load
Rated load		10 mA at 30 VAC
		10 mA at 30 VDC
		2.5 GHz, 50 Ω, 10 W (See note.)
Rated carry current		0.5 A
Max. switching voltage		30 VDC, 30 VAC
Max. switching current		0.5 A

■ High-frequency Characteristics

Item	Frequency	2.0 GHz	2.5 GHz
Isolation		65 dB min.	60 dB min.
Insertion loss		0.2 dB max.	
V.SWR		1.2 max.	
Max. carry power		20 W (See note.)	
Max. switching power		10 W (See note.)	

- Note:**
1. The above values are initial values.
 2. This values is for a load with V.SWR ≤ 1.2 at the impedance of 50 Ω.

■ Coil Ratings

Single-side Stable Relays (G6W-1F, G6W-1P)

Rated voltage	3 VDC	4.5 VDC	9 VDC	12 VDC	24 VDC
Rated current	66.7 mA	44.4 mA	22.2 mA	16.7 mA	8.3 mA
Coil resistance	45 Ω	101 Ω	405 Ω	720 Ω	2,880 Ω
Must operate voltage	80 % max. of rated voltage				
Must release voltage	10 % min. of rated voltage				
Maximum voltage	150 % of rated voltage				
Power consumption	Approx. 200 mW				

Single-winding Latching Relays (G6WU-1F, G6WU-1P)

Rated voltage	9 VDC	12 VDC
Rated current	22.2 mA	16.7 mA
Coil resistance	405 Ω	720 Ω
Must set voltage	80 % max. of rated voltage	
Must reset voltage	80 % max. of rated voltage	
Maximum voltage	150 % of rated voltage	
Power consumption	Approx. 200 mW	

Double-winding Latching Relays (G6WK-1F, G6WK-1P)

Rated voltage	3 VDC	4.5 VDC	9 VDC	12 VDC	24 VDC
Rated current	120 mA	80 mA	40 mA	30 mA	15 mA
Coil resistance	25 Ω	56 Ω	225 Ω	400 Ω	1,600 Ω
Must set voltage	80 % max. of rated voltage				
Must reset voltage	80 % max. of rated voltage				
Maximum voltage	150 % of rated voltage				
Power consumption	Approx. 360 mW				

- Note:**
1. The rated current and coil resistance are measured at a coil temperature of 23°C with a tolerance of ±10%.
 2. The operating characteristics are measured at a coil temperature of 23°C.
 3. The maximum voltage is the highest voltage that can be imposed on the Relay coil.

■ Characteristics

Item	Classification Model	Single-side Stable	Single-winding Latching	Double-winding Latching
		G6W-1F, G6W-1P	G6WU-1F, G6WU-1P	G6WK-1F, G6WK-1P
Contact resistance (See note 1.)		100 mΩ max.		
Operate (set) time (See note 2.)		10 ms max. (Approx. 3.5 ms)	10 ms max. (Approx. 2.5 ms)	
Release (reset) time (See note 2.)		10 ms max. (Approx. 2.5 ms)		
Minimum set/reset signal width		—	12 ms	
Insulation resistance (See note 3.)		1,000 MΩ min. (at 500 VDC)		
Dielectric strength	Coil and contacts	1,000 VAC, 50/60 Hz for 1 min		
	Coil and ground, contacts and ground	500 VAC, 50/60 Hz for 1 min		
	Contacts of same polarity	500 VAC, 50/60 Hz for 1 min		
Vibration resistance	Destruction	10 to 55 Hz, 1.5-mm double amplitude		
	Malfunction	10 to 55 Hz, 2-mm double amplitude		
Shock resistance	Destruction	1,000 m/s ²		
	Malfunction	500 m/s ²		
Endurance	Mechanical	1,000,000 operations min. (at 36,000 operations/hour)		
	Electrical	300,000 operations min. (with a rated load at 1,800 operations/hour)		
Ambient temperature		Operating: -40°C to 70°C (with no icing or condensation)		
Ambient humidity		Operating: 5% to 85%		
Weight		Approx. 3 g		

- Note:**
1. The contact resistance was measured with 10 mA at 1 VDC with a fall-of-potential method.
 2. Values in parentheses are actual values.
 3. The insulation resistance was measured with a 500-VDC Megger Tester applied to the same parts as those used for checking the dielectric strength.
 4. The above values are initial values.

Engineering Data

Ambient Temperature vs. Maximum Voltage

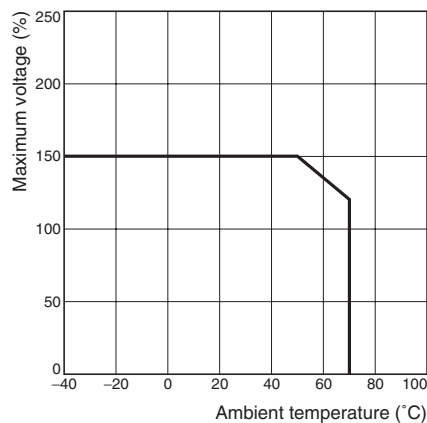

Note: "Maximum voltage" is the maximum voltage that can be applied to the Relay coil.

Ambient Temperature vs. Must Set or Must Reset Voltage

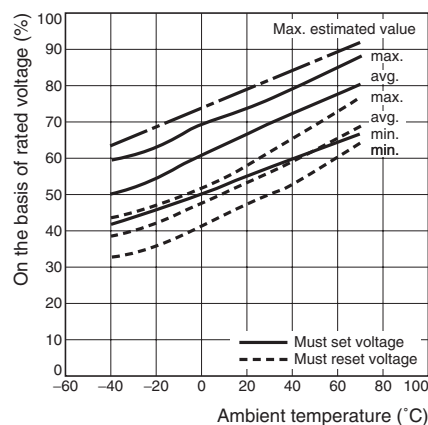

Shock Malfunction

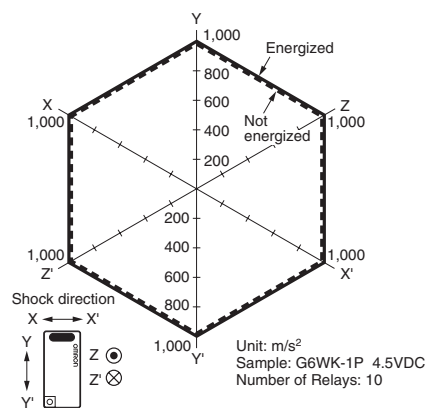

Conditions: Shock is applied in $\pm X$, $\pm Y$, and $\pm Z$ directions three times each with and without energizing the Relays to check the number of contact malfunctions.

**Electrical Endurance
(With Must Set and Must Reset
Voltage)**

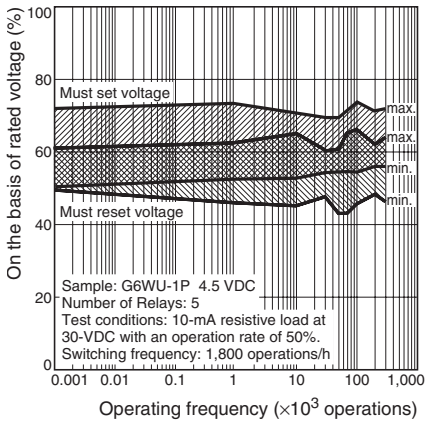

**Electrical Endurance
(With Must Set and Must Reset
Voltage)**

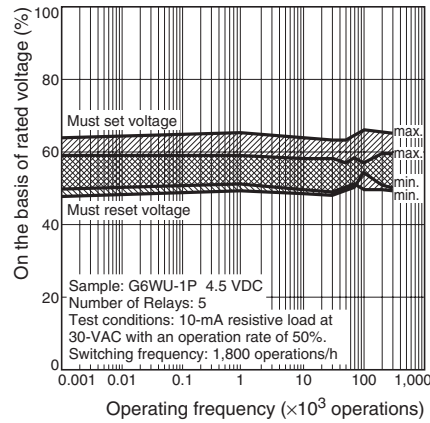

**Electrical Endurance
(Contact Resistance)**

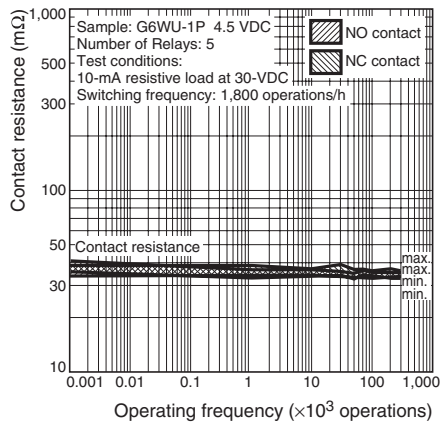

**Electrical Endurance
(Contact Resistance)**

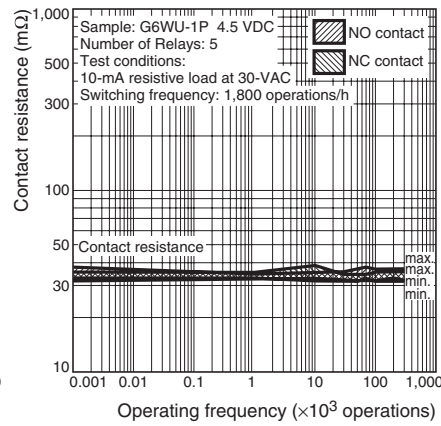

External Magnetic Interference

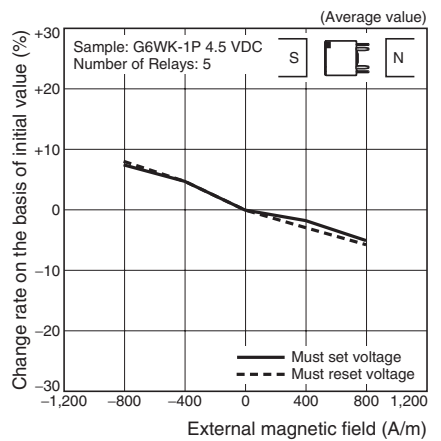
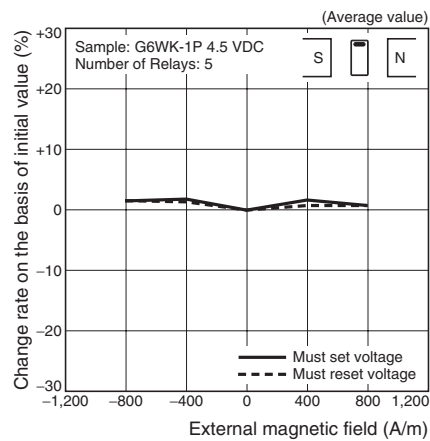
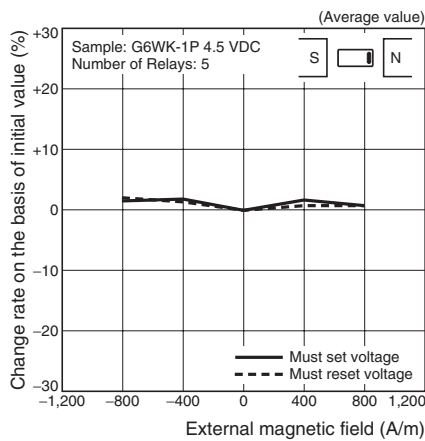

High-frequency Characteristics (Isolation)

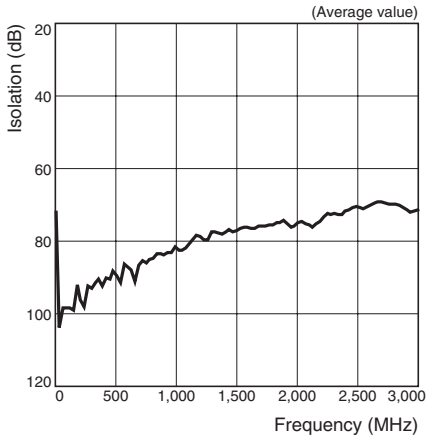

High-frequency Characteristics (Insertion Loss)

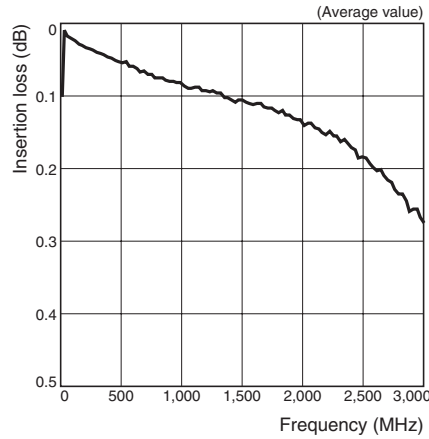

High-frequency Characteristics (Return Loss)

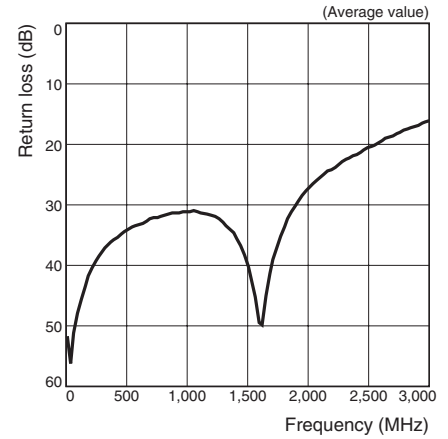

Must Set and Must Reset Time Distribution (See note.)

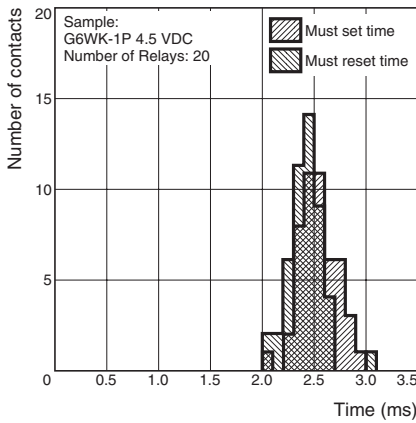

Must Set and Must Reset Bounce Time Distribution (See note.)

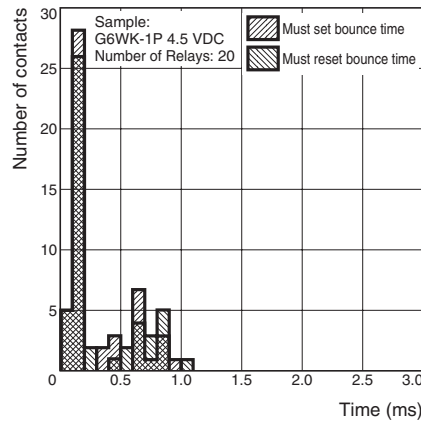

Note: The tests were conducted at an ambient temperature of 23°C.

Dimensions

Note: All units are in millimeters unless otherwise indicated.

**G6W-1F
G6WU-1F**

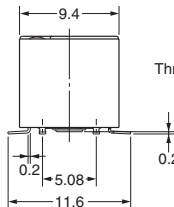
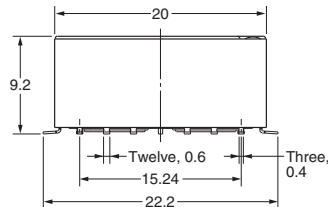
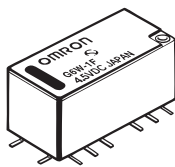

PCB Mounting Holes (Top View)

Tolerance: ± 0.1 mm

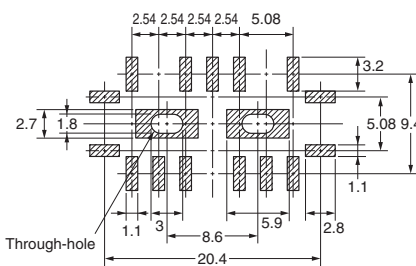

Terminal Arrangement/ Internal Connections (Top View)

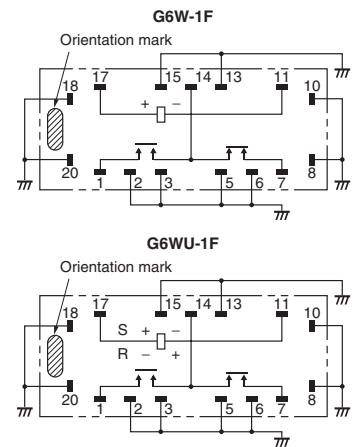

Note: Each value has a tolerance of ± 0.3 mm.

Recommended Soldering Method

IRS Method (for Surface-mounting Terminal Relays)

- Temperatures indicate the surface temperatures of the PCB.

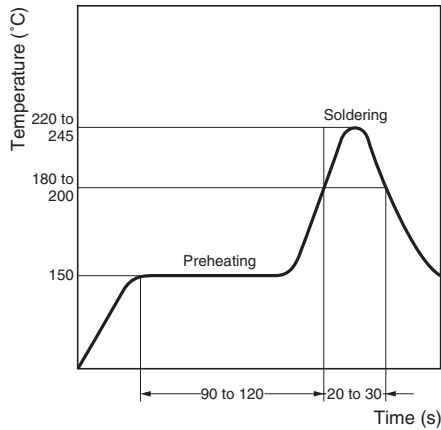

- The thickness of cream solder to be applied should be within a range between 150 and 200 μm on OMRON's recommended PCB pattern.

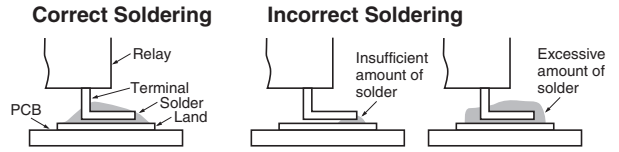

Visually check that the Relay is properly soldered.

Precautions

For general precautions, refer to the *PCB Relay Catalog (X033)*. Familiarize yourself with the precautions and glossary before using the G6W.

Correct Use

High-frequency Characteristics Measurement Method and Substrate to be Measured

High-frequency Characteristics for G6W are measured as shown below.

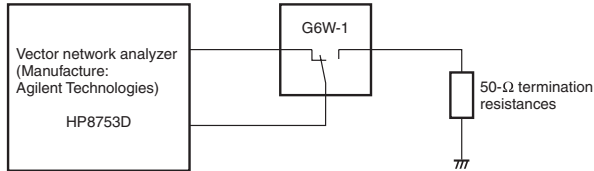

Through-hole substrate

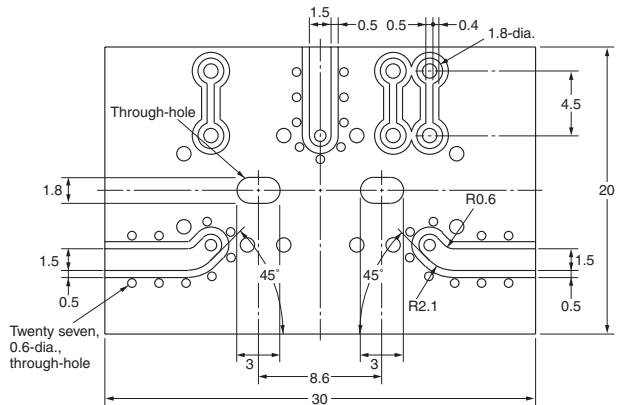

Undersurface of relay

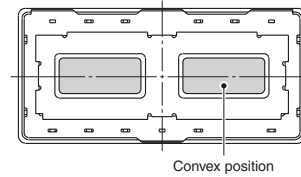

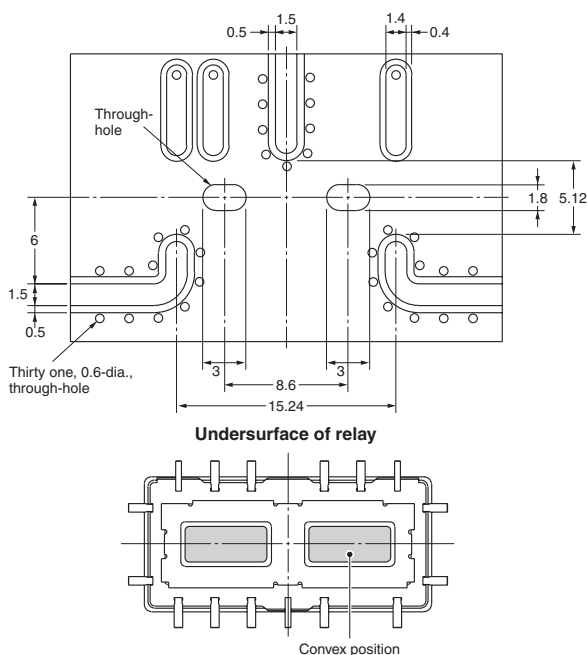
SMD-type substrate

Note: When higher isolation is required, connect the convex position on the undersurface of the relay to the ground pattern of the substrate by soldering.

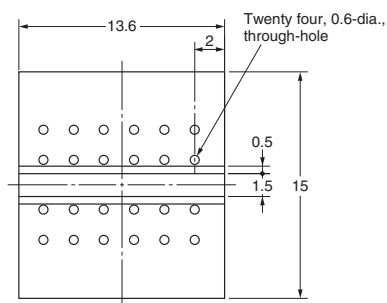
Base plate for high-frequency characteristic compensation

Note: The above compensation plate is used to measure the loss by the relay. The relay loss is determined by subtracting the data measured for a compensation base plate from those for a high-frequency characteristics measuring substrate mounted with a relay.

Handling

Leave the Relays packed until just prior to mounting them.

Soldering

Solder: JIS Z3282, H63A

Soldering temperature: Approx. 250°C (At 260°C if the DWS method is used.)

Soldering time: Approx. 5 s max. (approx. 2 s for the first time and approx. 3 s for the second time if the DWS method is used.)

Be sure to adjust the level of the molten solder so that the solder will not overflow onto the PCB.

Claw Securing Force During Automatic Insertion

During automatic insertion of Relays, make sure to set the securing force of the claws to the following values so that the Relay characteristics will be maintained.

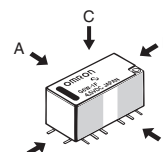

Direction A: 4.90 N max.

Direction B: 9.80 N max.

Direction C: 9.80 N max.

Secure the claws to the area indicated by shading. Do not attach them to the center area or to only part of the Relay.

Environmental Conditions During Operation, Storage, and Transportation

Protect the Relays from direct sunlight and keep the Relays under normal temperature, humidity, and pressure.

Latching Relay Mounting

Make sure that the vibration or shock that is generated from other devices, such as relays in operation, on the same panel and imposed on the Latching Relay does not exceed the rated value, otherwise the Latching Relay that has been set may be reset or vice versa. The Latching Relay is reset before shipping. If excessive vibration or shock is imposed, however, the Latching Relay may be set accidentally. Be sure to apply a reset signal before use.

Coating

Relays mounted on PCBs may be coated or washed. Do not apply silicone coating or detergent containing silicone, otherwise the silicone coating or detergent may remain on the surface of the Relays.

ALL DIMENSIONS SHOWN ARE IN MILLIMETERS.

To convert millimeters into inches, multiply by 0.03937. To convert grams into ounces, multiply by 0.03527.

Cat. No. K120-E1-01 In the interest of product improvement, specifications are subject to change without notice.

OMRON Corporation

Electronic Components Company

Electronic & Mechanical Components Division H.Q.

Low Signal Relay Division

2-1, 2-Chome, Nishikusatsu, Kusatsu-City,

Shiga, 525-0035 Japan

Tel: (81)77-565-5481/Fax: (81)77-565-5581

Printed in Japan

0402-2M (0402) (B)